

TopShield® PRO
Uncompromising Commitment to Quality

APPLICATION INSTRUCTION MANUAL

SELF-ADHERED SBS-MODIFIED BITUMEN ROOF SYSTEMS
Includes Application Instructions for Ambient Temperatures, 20°F – 49°F



SELF ADHERED SBS-MODIFIED BITUMEN ROOFING SYSTEM FOR LOW SLOPE ROOFS

TopShield® PRO SA is a premium, self-adhered SBS-modified bitumen roofing system. With high quality materials bottom to top, components of the TopShield® PRO SA system include: TopShield® PRO SA NailBase (base/anchor—mechanically attached) TopShield® PRO SA PlyBase (base or interply, self-adhered) TopShield® PRO SA Cap (self-adhered)

WHAT ARE THE ADVANTAGES?

Self-adhered roofing offers the time-tested protection of modified bitumen roof systems for a fraction of the labor with no fumes, flame, asphalt kettle or occupant disturbance. The application of self-adhered low-slope roof systems is also easier to master than traditional bituminous application methods.

TopShield® PRO SA systems are valued for:

- Superior initial and long-term bonds;
- Excellent applicator handleability in hot or cold temperatures;
- Allowed application temperatures as low as 20°F (cold weather application instructions must be followed when ambient temperatures are between 20°F - 49°F);
- Wide array of cap sheet colors blended to complement popular shingles;
- Excellent sales and applicator support.

WHERE CAN I USE IT?

The value associated with labor savings and safety can be applied to any roof project. In addition, TopShield® PRO SA roof systems are ideal when access to the roof is limited, such as high-rise buildings. And no asphalt kettle means no odor, which makes SA systems an ideal solution on healthcare, education, hospitality and residences/condos where occupant comfort is tremendously desirable.

CONSIDERATIONS FOR INTENDED USE

If multiple SA products are listed, products are listed in order of warranty duration from shortest to longest, with the exception of SA Cap and - is intended for use where Class A fire rating is required (see iq.ulprospector.com for Class A system specification). NOTE: Removal of the roof system (at end of life) may be difficult when adhering PlyBase or - direct to a roof deck (i.e. wood, concrete).



THE TOPSHIELD® PRO SA FAMILY OF PRODUCTS

TopShield® PRO offers two types of primers for use with TopShield® PRO SA systems. TopShield® #3 asphalt primer and TopShield® #56 SA quick-dry, water-based primer are designed to enhance the adhesion of self-adhered roofing membranes. Available in 14 oz spray cans, 5-gallon pails and 55 gallon pails.

TopShield® #33 is a premium grade flashing cement and adhesive. With TopShield® PRO SA membranes, TopShield® #33 may be used for endlap, sidelap bead and vertical flashing details. Available in 10.3 oz caulk tube, 3 gallon, and 5 gallon pails. A hot air welder, in combination with a hand-held silicone roller, may be used for these details in lieu of TopShield® #33 and is required for cold weather applications.

IMPORTANT APPLICATION CONSIDERATIONS

Every professional roofer is familiar with the tools needed to complete a roof installation, but just as a recap, specific tools you'll need to install TopShield® PRO SA include:

- A weighted roller for pressing the membrane into place, 2" to 4" in diameter (70 lbs.);
- Suitable trowel for applying TopShield® #33 to flashing details;
- Roofer's knife with hooked blade;



Scan QR code or Visit
TopShieldProducts.com

SA SYSTEMS BY DECK TYPE

Deck	Insulation/Coverboard*	SA Anchor/Base	SA Interply	SA Cap
Steel	Required	NailBase (MF) PlyBase	Optional PlyBase	SA Cap (SA)
Wood/LWIC Other, i.e. Gypsum, Cementitious Wood Fiber, Wood Planks Structural Wood Fiber, etc	Optional	NailBase (MF)		
	Required if base is self-adhered	PlyBase		
Concrete	Optional	NailBase (MF)		
	Optional, if “no”, self-ad- hered base requires Primer	PlyBase		

- Caulk gun for applying beads of TopShield® #33
- Seam probing tool to check for voids;
- Hot Air Welder for cold weather applications or, if preferred, for flashing details year round;
- **AS NEEDED:** Long-handled (standing) roller with 1/8" - 1/4" nap for applying primer (1/8" nap for smooth surfaces, 1/4" nap for more porous surfaces).

Please Keep in Mind:

- Do not attempt application if ice, snow, moisture or dew are present. As noted throughout the manual, when ambient temperatures are between 20°F and 49°F, cold weather application instructions must be followed.
- Substrates must be free of dust, dirt, oil, debris and moisture.
- Store TopShield® PRO SA rolls indoors on upright pallets, protected from the elements. Rolls that are improperly stored or have been warehoused for prolonged periods of time may lose their tack and should not be used. In cold weather rolls **MUST** be stored indoors, minimum 60°F, or in warming huts prior to application; **DO NOT INSTALL COLD ROLLS.**
- If the material isn't bonding, **STOP** the application!
- Always remember to put safety first and follow all OSHA safety guidelines with any roofing installation.
- Primer, if used, must be applied at the specified rate and must be allowed to cure as specified.
- Work with manageable lengths of base, ply and cap membranes for the particular job. Where appropriate, cut rolls into 1/3- or 1/2 -roll lengths.
- Allow material to relax a minimum of 15 minutes prior to installation. In cold weather allow rolls to relax indoors or in warming huts if possible; avoid allowing rolls to fall below 50°F (avoid material contraction).

- **All plies of the assembly should be installed in one day. If maroon film must be exposed for longer periods of time, cover with tarp or suitable alternate protection.**
- Do not mix TopShield® PRO SA membranes with other types of roof membranes. TopShield® PRO SA membranes are specifically designed to be applied together. The permanent top film of the base and ply sheets cannot receive torching, hot asphalt or other non self-adhered application methods. The TopShield® PRO SA Cap, PlyBase cannot be applied to any surfaces other than as described herein.
- When applying TopShield® PRO SA on slopes exceeding 1" in 12", membranes shall be back nailed. When applied parallel to the slope, TopShield® PRO SA shall be blind-nailed at end laps 2" in from top edge, 6" o.c. through tin discs and to wood nailers.
- When using TopShield® #33 for flashing details, target 1/4" TopShield® #33 bleed out at endlap areas. Use caution not to roll weighted roller into bleed out."
- Do not use cold adhesives, such as TopShield® #33, with TopShield® PRO SA membranes other than for flashing details and cap sheet overlaps as described herein.

Cold Weather Application:

- Store materials in a heated location and draw materials as needed. If the materials have been exposed to cold temperatures, allow a sufficient period of time in a heated environment for them to warm to 50°F. **DO NOT INSTALL COLD ROLLS.**
- A hot air welder, in combination with a hand-held silicone roller, should be utilized to heat and seal sidelaps, endlaps and details. Specific "heat and roll" instructions are included within subsections of this manual. **DO NOT** overheat or attempt to weld laps with a torch.



APPLICATION OF BASE SHEET

TopShield® PRO SA NailBase may be used as an anchor sheet (mechanically fastened); PlyBase may be used as a base ply (fully adhered, water-tight). **NOTE:** PlyBase may also be used as interply layers in three-ply systems, see Application of Interply (Optional).

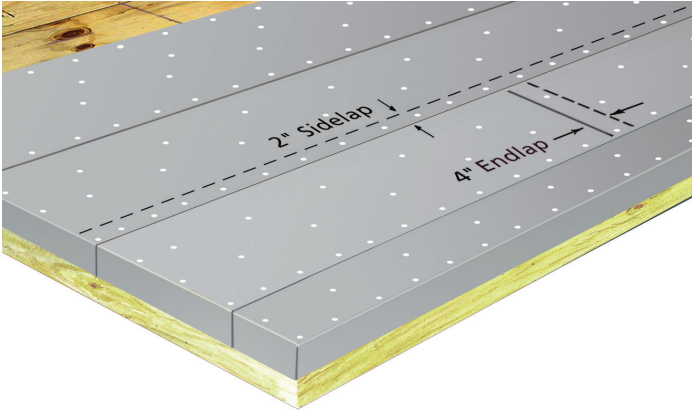

FIELD DETAILS REFERENCE					
	2-PLY SYSTEMS		3-PLY SYSTEMS		
	Base	Cap	Base	Ply	Cap
Starter row width	19-11/16" (1/2 roll)	39-3/8" (full roll)	26-1/4" (2/3 roll)	19-11/16" (1/2 roll)	39-3/8" (full roll)
Side laps	2"	3"	2"	2"	3"
End laps, staggered 36"	4"	6"	4"	4"	6"

Mechanically Attached Base

Beginning at the low point of the roof, mechanically fasten TopShield® PRO SA NailBase to nailable deck using appropriate fasteners (see Fasteners chart). Start with an appropriate roll width (see Field Details Reference) to accommodate offsetting of sidelaps of subsequent layers in the roof system for increased water protection. Install so that no sidelaps are against the flow of water. A minimum fastening pattern is every 9" on center on sidelaps and every 18" on center in two staggered rows in the field of the sheet. Overlap base sheet sidelaps a minimum 2" and endlaps 4". Mechanically Attached Base

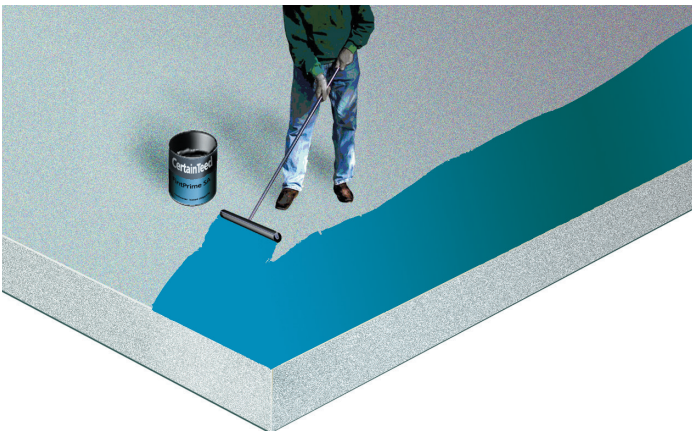

Turn base sheet over facia by 2" and fasten. Offset end-laps of adjacent courses a minimum of 3'. **Do Not Leave Base Sheet Exposed To The Weather.** Cover in the same day with optional SA interply and/or SA Cap.

Self-Adhered Base

SA PlyBase may be self-adhered to approved substrates such as mechanically fastened or adhered ISO Cold, or primed substrates (i.e. concrete roof decks, gypsum coverboards, etc).

Allow primer to dry thoroughly. If substrate (i.e. ISO) is attached with fasteners, prime exposed metal with TopShield® #3 Primer before adhering SA PlyBase. Before adhering a base ply, sweep the surface of the deck or insulation to remove any debris that could interfere with adhesion.

Begin application at the low point of the roof. Start with an appropriate roll width (see Field Details Reference) to accommodate offsetting of sidelaps of subsequent layers in the roof system for increased water protection. Install flush to roof edge. Design layout so that no sidelaps are against the flow of water.

Cut rolls into manageable lengths and allow to relax a minimum of 15 minutes. Fold the membrane back halfway lengthwise to remove the split release film. Press membrane securely into place and repeat with the opposite half of the membrane. Use a heavy, weighted roller over the entire surface of the PlyBase to secure the membrane. Work from the center of the roll outwards across the width to eliminate air pockets; **DO NOT** roll lengthwise as it can cause the roll to stretch.

Overlap sidelaps of subsequent SA PlyBase membrane courses a minimum 2" and end-laps 4". Offset (stagger) endlaps of adjacent courses a minimum 3'. Cut endlaps at opposing diagonal corners at an angle approximately 5-1/2" long by the selvage dimension from the corners to minimize "T"- seams. Apply a bead or small trowel dab (quarter size) of TopShield® #33 All Weather Rubberized Cement at the edge of the angled cut to avoid a capillary. Use of a hand-held hot air gun at the joint area prior to rolling the membrane will maximize adhesion. It is recommended to apply a bead of SBS Modified Bitumen Adhesive, Caulk grade, at all SA PlyBase side and endlaps edges to eliminate a capillary.

Do Not Leave Base Sheet Exposed To The Weather. Cover in the same day with optional SA interply and/or SA Cap.



Scan QR code or Visit
TopShieldProducts.com

FASTENER REFERENCE

Standard (Round Head) Roofing Nails and Cap
(Note: TopShield® PRO does not permit the use of plastic caps) For use with Base Sheet, Flash/Termination Bar on Plywood Decks, Non Veneer Decks, Wood Plank Decks



Large Head Roofing Nails

For use with Base Sheet, Flash/Termination Bar on Plywood Decks, Non Veneer Decks, Wood Plank Decks

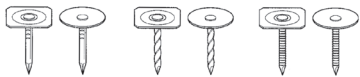

Base Sheet Fasteners for some Cementitious Roof Decks For use with Base Sheet on Light Weight Insulation Concrete, Poured Gypsum



Self-Locking Fasteners

For use with Base Sheet on Cement/Wood Fiber



Insulation Fasteners

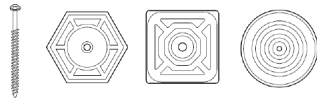

debris that could interfere with adhesion. Cut rolls to manageable lengths and allow to relax for a minimum of 15 minutes. Start with SA PlyBase at the low point of the roof with appropriate roll width to offset sidelaps 18" from sidelaps of underlying anchor sheet or base ply (see Field Details chart) all flush to roof edge. Design layout so that no sidelaps are against the flow of water.

Fold the membrane back halfway lengthwise to remove the split release film. Press membrane securely into place and repeat with the opposite half of the membrane. Use a heavy, weighted roller over the entire surface of the SA PlyBase to secure the membrane. Work from the center of the roll outwards across the width to eliminate air pockets; **DO NOT** roll lengthwise as it can cause the roll to stretch.

Overlap sidelaps of subsequent SA PlyBase membrane courses a minimum 2" and endlaps 4". Offset (stagger) endlaps of adjacent courses a minimum 3'.

Cut endlaps at opposing diagonal corners at an angle approximately 5-1/2" long by the selvage dimension from the corners to minimize potential water incursion at T-Seams (see T-Seam Detail). Apply a bead or small trowel dab (quarter size) of TopShield® #33 All Weather Rubberized Cement at the edge of the angled cut to avoid a capillary. Use of a hand-held hot air gun at the joint area prior to rolling the membrane will maximize adhesion. It is recommended to apply a bead of TopShield® #33 SBS Modified Bitumen Adhesive, Caulk grade, at all SA PlyBase side and endlap edges to eliminate a capillary.

Do Not Leave Base Sheet Exposed To The Weather. Cover in the same day with SA Cap.

COLD WEATHER APPLICATION INSTRUCTIONS, BASE SHEET

When ambient temperatures are between 20°F - 49°F;

- Whether base sheet is mechanically attached or self-adhered, store materials in a heated location and draw materials as needed. If the materials have been exposed to cold temperatures, allow a sufficient period of time in a heated environment for them to warm to 50°F. **DO NOT INSTALL COLD ROLLS.**
- No additional cold weather application precautions are required for base sheets.

APPLICATION OF INTERPLY (OPTIONAL)

Note: Proceed to "Before Installing TopShield® PRO SA Cap if installing a 2-ply system.

Before installing TopShield® PRO SA PlyBase sweep the underlying anchor sheet or base ply to remove any

COLD WEATHER APPLICATION INSTRUCTIONS, INTERPLY SHEET

When ambient temperatures are between 20°F - 49°F;

- Store materials in a heated location and draw materials as needed. If the materials have been exposed to cold temperatures, allow a sufficient period of time in a heated environment for them to warm to 50°F. **DO NOT INSTALL COLD ROLLS.**
- No additional cold weather application precautions are required for interply sheets.

BEFORE INSTALLING TOPSHIELD PRO SA CAP

If roof edge detail utilizes edge metal, proceed as follows.



Scan QR code or Visit
TopShieldProducts.com

Edge Metal for Two-Ply Systems (with no interply)

If an interply is not installed, install a 9" wide flashing

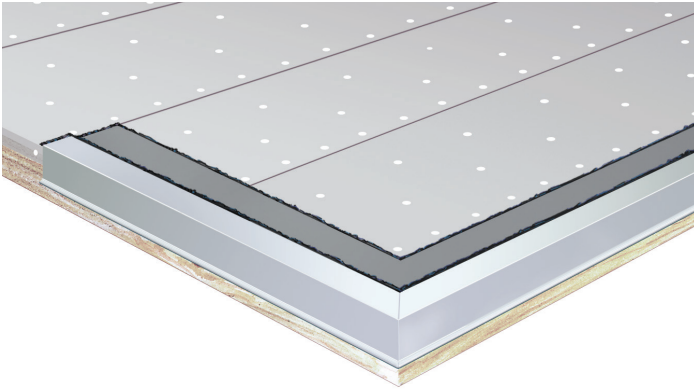

strip of SA PlyBase (material assumed to match base sheet if fully adhered) onto the field of the roof and flush to the roof edge, self-adhered.

Install minimum 26 gauge edge metal using appropriate fasteners, set entirely in a uniform 1/8" - 1/4" thick troweling of TopShield® #33. Fasten edge metal through the surface, through the anchor and flashing strip, into the deck using appropriate fasteners (see Fastener Reference), spaced 4" on center in two staggered rows. Remove any oil from the metal surface using a vinegar and water solution. Prime the horizontal surface of the metal and allow primer to dry. Apply a bead of caulk grade TopShield® #33 at the roof side edge of the metal where it meets the flashing strip.

Edge Metal for Three-Ply Systems (with interply)

If an interply has been installed over the base sheet, install minimum 26 gauge edge metal using appropriate fasteners and set in 1/8" - 1/4" bed of TopShield® #33 Trowel adhesive. Fasten edge metal through the metal surface, through the base/interply and into the deck using appropriate fasteners (see Fastener Reference), spaced 4" on center in two staggered rows. Remove any oil from the metal surface using a vinegar and water solution. Prime the horizontal surface of the metal with TopShield® #3 Primer and allow to dry/tackify. Apply a bead of caulk grade TopShield® #33 to the edge of the metal where it meets the SA PlyBase. Proceed to installing SA Cap.

APPLICATION OF TOPSHIELD PRO SA CAP

Before installing TopShield® PRO SA Cap sweep the underlying sheet to remove any debris that could inter-

fere with adhesion. Then start at the low point of the roof with a full roll width to offset sidelaps from the underlying membrane a minimum of 18" (see Field Details

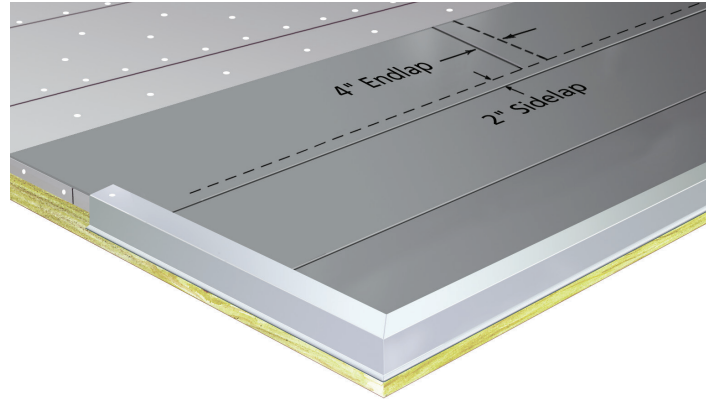

Reference). Cut rolls into manageable lengths and allow to relax for a minimum of 15 minutes.

Position SA Cap with selvage edge release strip at high side of roof and the opposite side flush to the roof's edge. Once positioned, lift and fold back (lengthwise) the lower half of the membrane. Remove the split release film and press firmly into place. Then repeat with the other (high side of the roof) half of the membrane.

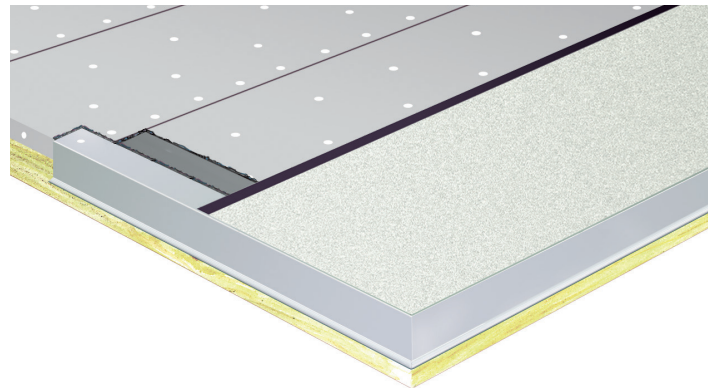

Follow the same layout and split release film procedures as for SA PlyBase, but overlap sidelaps 3" and endlaps 6". Install in weather-lapped fashion, with no laps against the flow of water. Use a weighted roller over the entire surface of TopShield® PRO SA Cap - to secure it in place and prevent voids, from the center of the roll outwards across the width to eliminate air pockets; **DO NOT** roll lengthwise as it can cause the roll to stretch. As subsequent membrane lengths are installed, remove the selvage edge release strip just prior to overlapping to keep the adhesive area protected and clean.

Cut endlaps at opposing diagonal corners at an angle approx. 3" by 5-1/2" from the corners to minimize water incursion at T-seams (see T-Seam Detail below). Treat rake



Scan QR code or Visit
TopShieldProducts.com

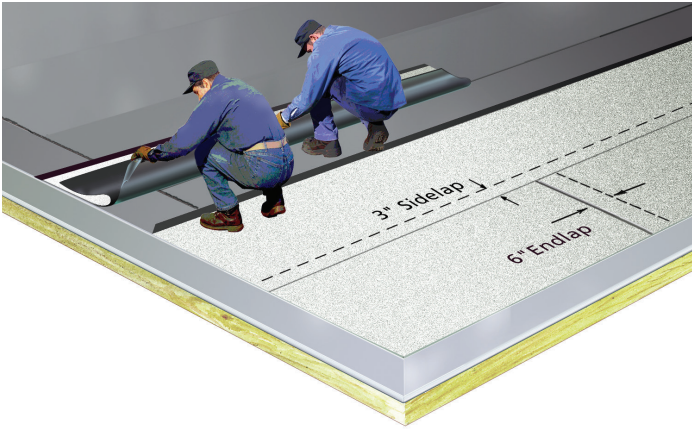

edge application similarly, cutting diagonal corners off Cap selvage edge above rake metal.

One of the following options must be followed for any granule over granule overlap, such as an endlap:

- Apply a uniform 1/8" - 1/4" troweling of TopShield® #33® Trowel to the entire 6" width of the underlying sheet, extending beyond underlying lap 1/4" or;
- Apply heat from a hot-air welder with a 2" tip to the overlapped sheet while applying rolling pressure from a silicone roller to the overlapping sheet. With the hot air welder set between 900°F-1,100°F (setting 8-10), apply heat to the overlapped granulated surface while bonding the overlapping SA Cap with rolling pressure. Roll the overlapping SA Cap in place, moving the hot air welder to allow for forward progress. Avoid applying so much heat or moving at a pace that results in smoke. A 6" endlap requires three passes. Apply a bead of TopShield® #33 Caulk along the edge. **WHEN AMBIENT TEMPERATURES ARE BETWEEN 20°F - 49°F THE HOT-AIR WELDER METHOD MUST BE APPLIED.**

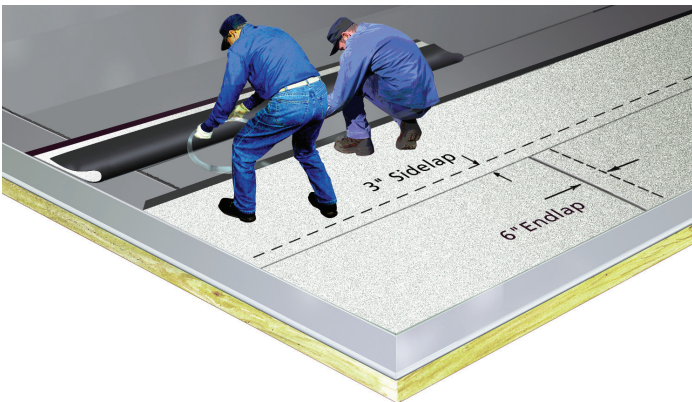

Once the membrane has had a chance to bond, check all laps and joints for full adhesion. If the membrane can be lifted at any area it is not properly adhered. A seam

probing tool can be helpful to check for voids at laps. If necessary, use appropriate hand-held hot air welding tool and seam roller or an application of TopShield® #33 to seal unbonded areas if they exist.

COLD WEATHER APPLICATION INSTRUCTIONS, CAP SHEET

When ambient temperatures are between 20°F - 49°F:

- Store materials in a heated location and draw materials as needed. If the materials have been exposed to cold temperatures, allow a sufficient period of time in a heated environment for them to warm to 50°F. **DO NOT INSTALL COLD ROLLS.**
- For edge metal details apply heat from a hot-air welder with a 2" tip to the overlapped, primed metal surface while applying rolling pressure from a silicone roller to the overlapping SA Cap. With the hot air welder set between 300°F-500°F (setting 2-3), apply heat to the lap interface while bonding SA Cap with rolling pressure on the granulated surface. Roll the lap in place, moving the hot air welder to allow for forward progress. Avoid applying so much heat or moving at a pace that results in smoke. Apply a bead of TopShield® #33 Caulk along the edge.
- Apply the same "heat and roll" technique as described above at all sidelaps. Apply a bead of TopShield® #33 Caulk along the edge.
- Apply a similar "heat and roll" to endlaps with the hot air welder set between 900°F-1,100°F (setting 8-10). A 6" endlap requires three passes. Apply a bead of TopShield® #33 Caulk along the edge.

CONSTRUCTION DETAILS

Included in this manual are a few common construction details. Please refer to the NRCA for details not found within this manual. Important to note with all details, all metal must be primed and set in TopShield® #33 Trowel adhesive and all overlaps over mineral surfacing must utilize either TopShield® #33 Trowel or the combination of a hot-air welder and silicone roller (cold weather requirement).



Scan QR code or Visit
TopShieldProducts.com

TYPICAL CONSTRUCTION DETAILS - TOPSHIELD® PRO SA 2 PLY SYSTEMS

Edge Flashing

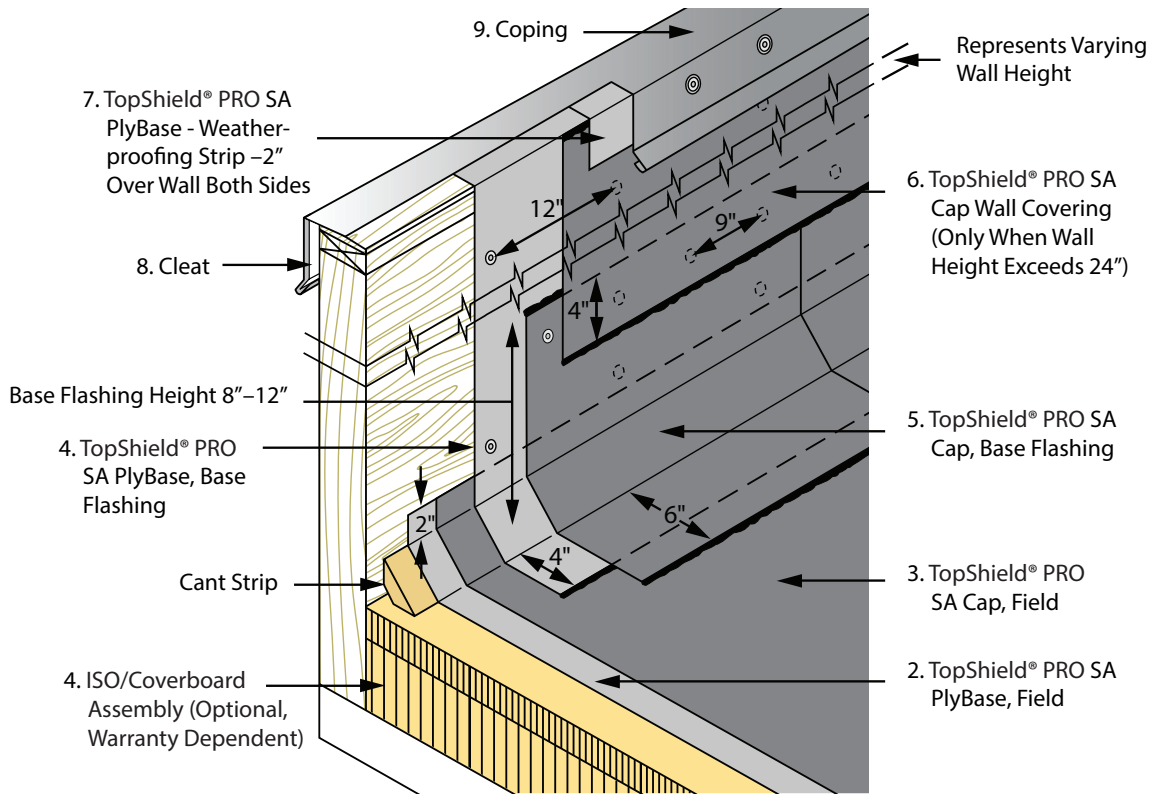
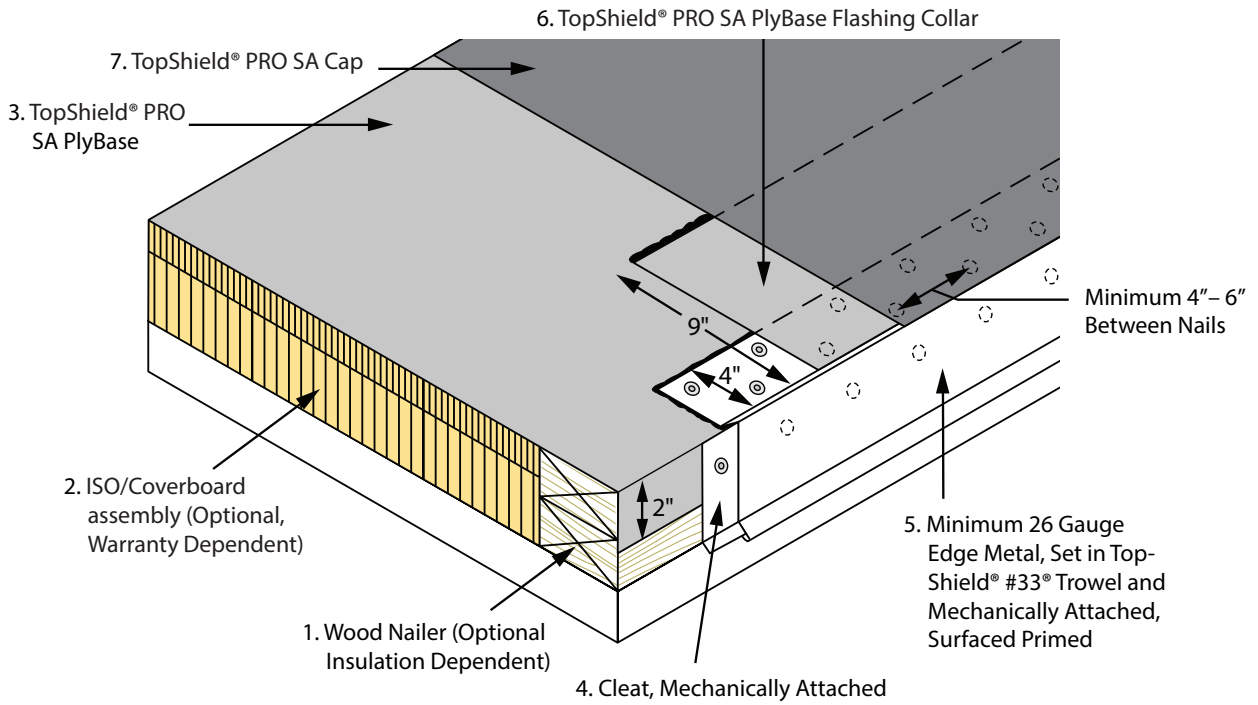

Base Flashing and Wall Covering on Parapet Wall



Scan QR code or Visit
TopShieldProducts.com

TYPICAL CONSTRUCTION DETAILS - TOPSHIELD® PRO SA 2 PLY SYSTEMS

Base Flashing on Parapet Wall, Inside Corner

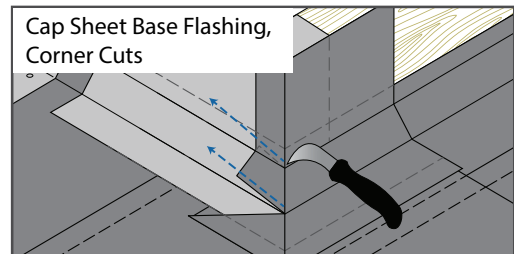
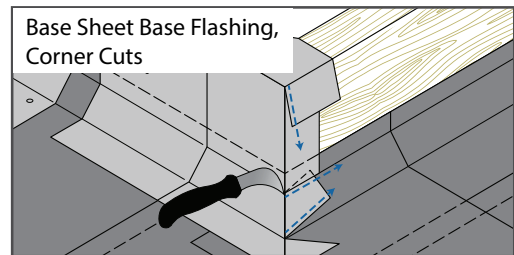
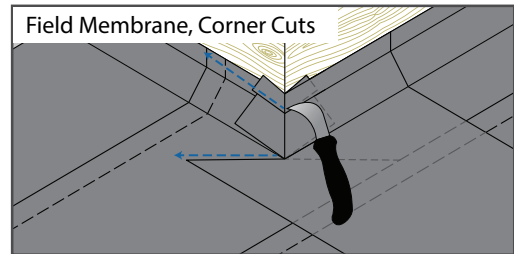
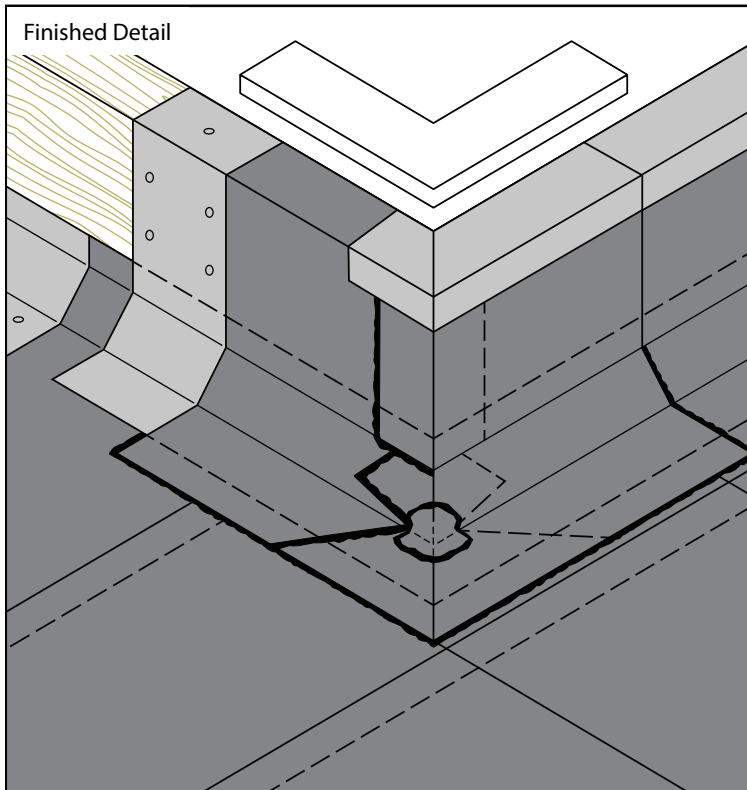
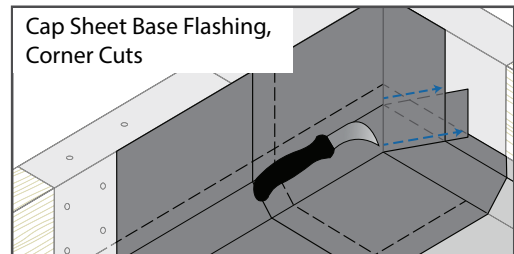
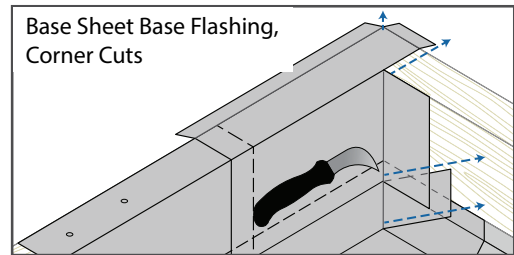
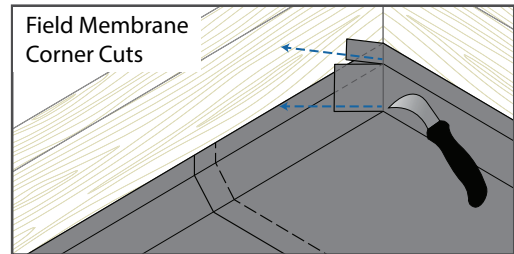
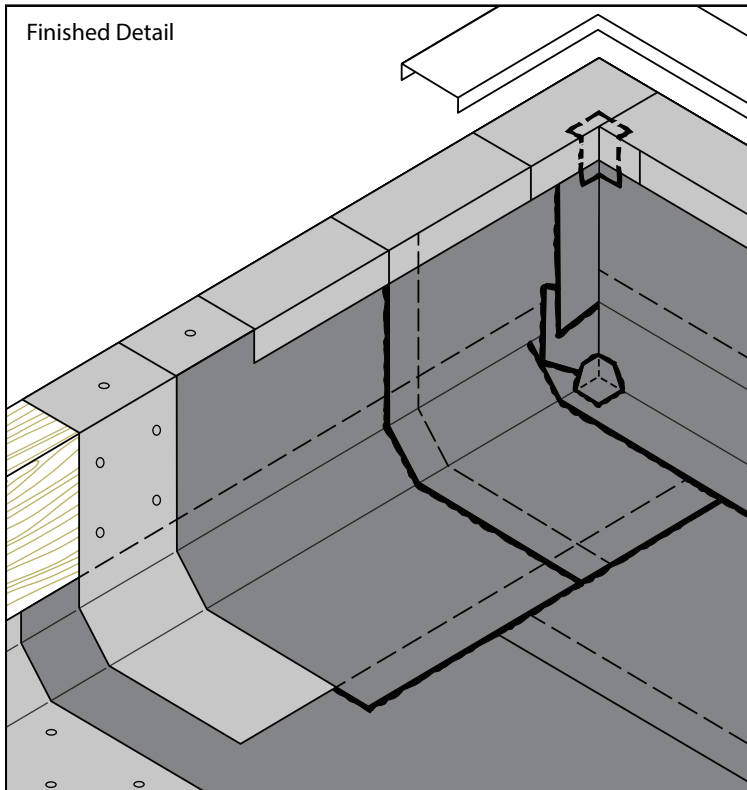

Base Flashing on Parapet Wall, Outside Corner



Scan QR code or Visit
TopShieldProducts.com

TYPICAL CONSTRUCTION DETAILS - TOPSHIELD® PRO SA 2 PLY SYSTEMS

End Lap Detail

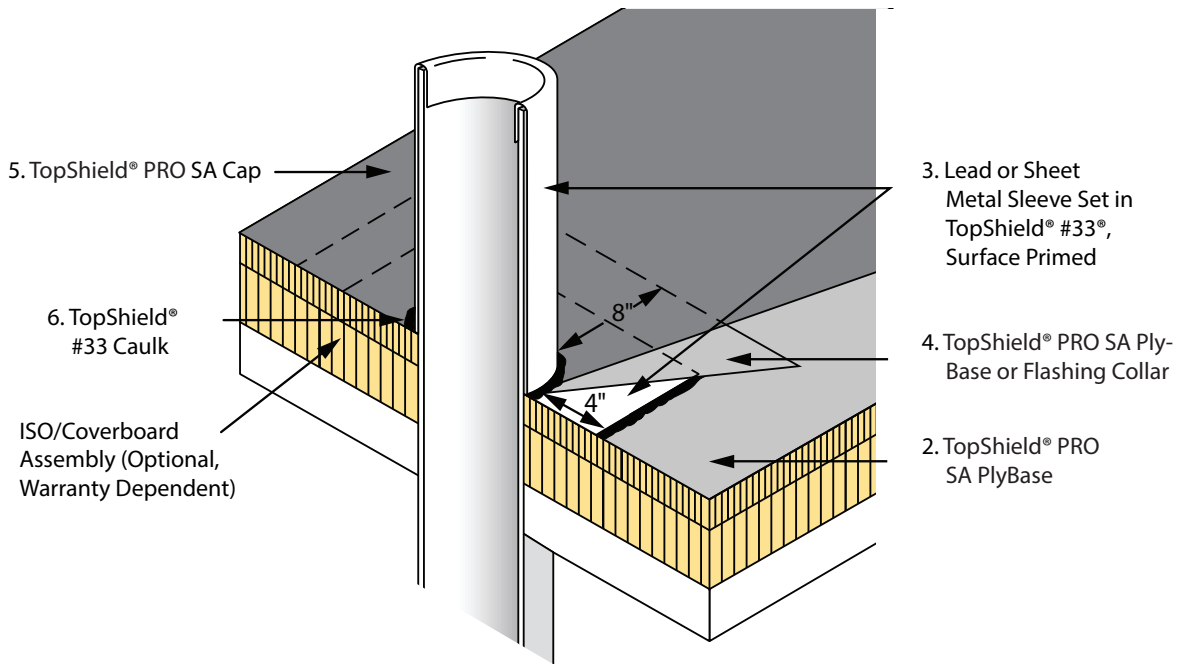
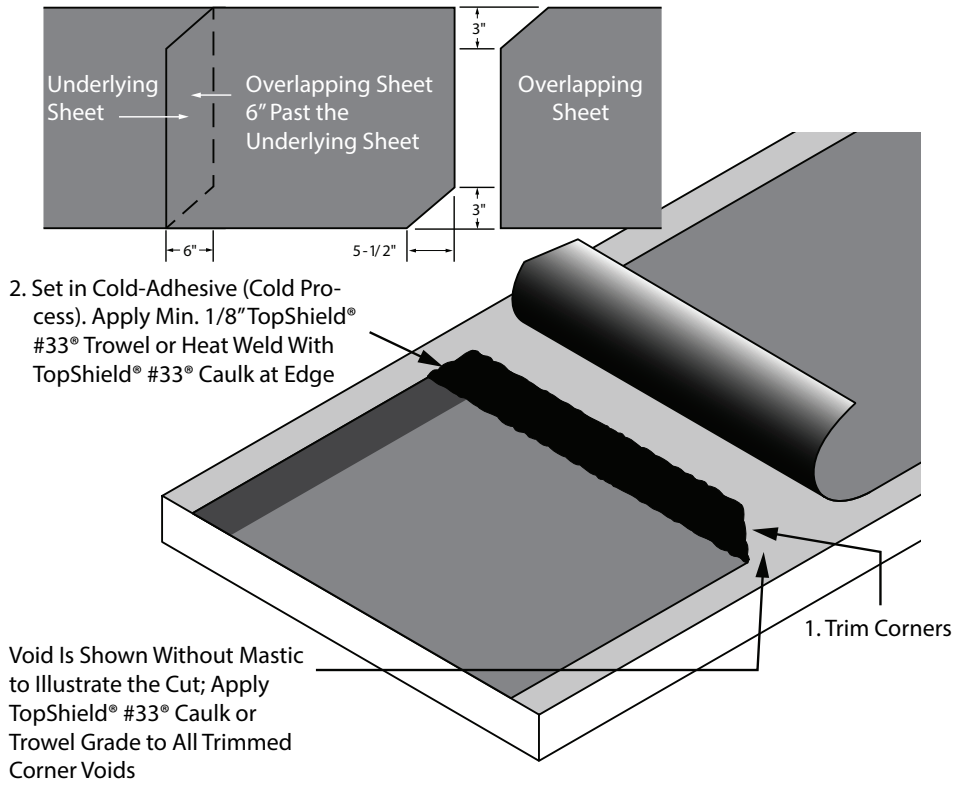

Pipe Flashing - Lead or Sheet Metal



TYPICAL CONSTRUCTION DETAILS - TOPSHIELD® PRO SA 2 PLY SYSTEMS

Through-Wall Scupper Flashing

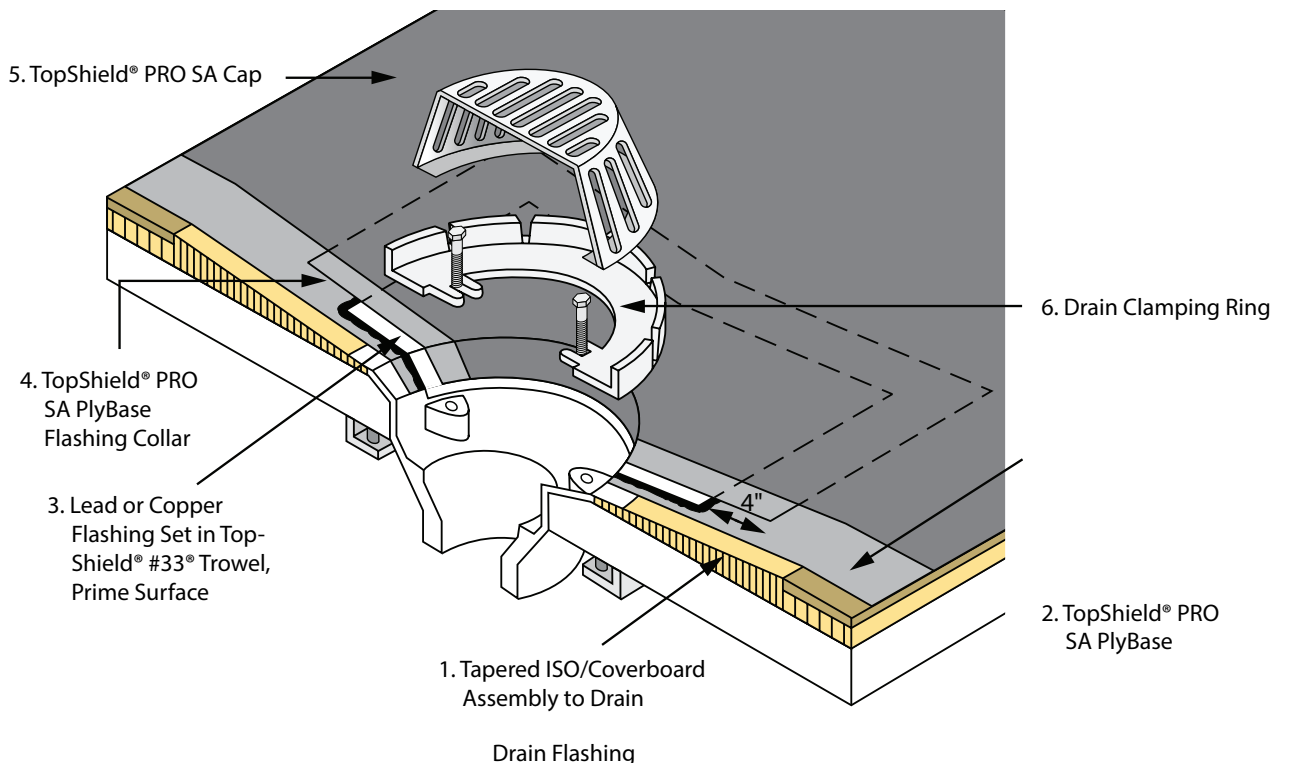
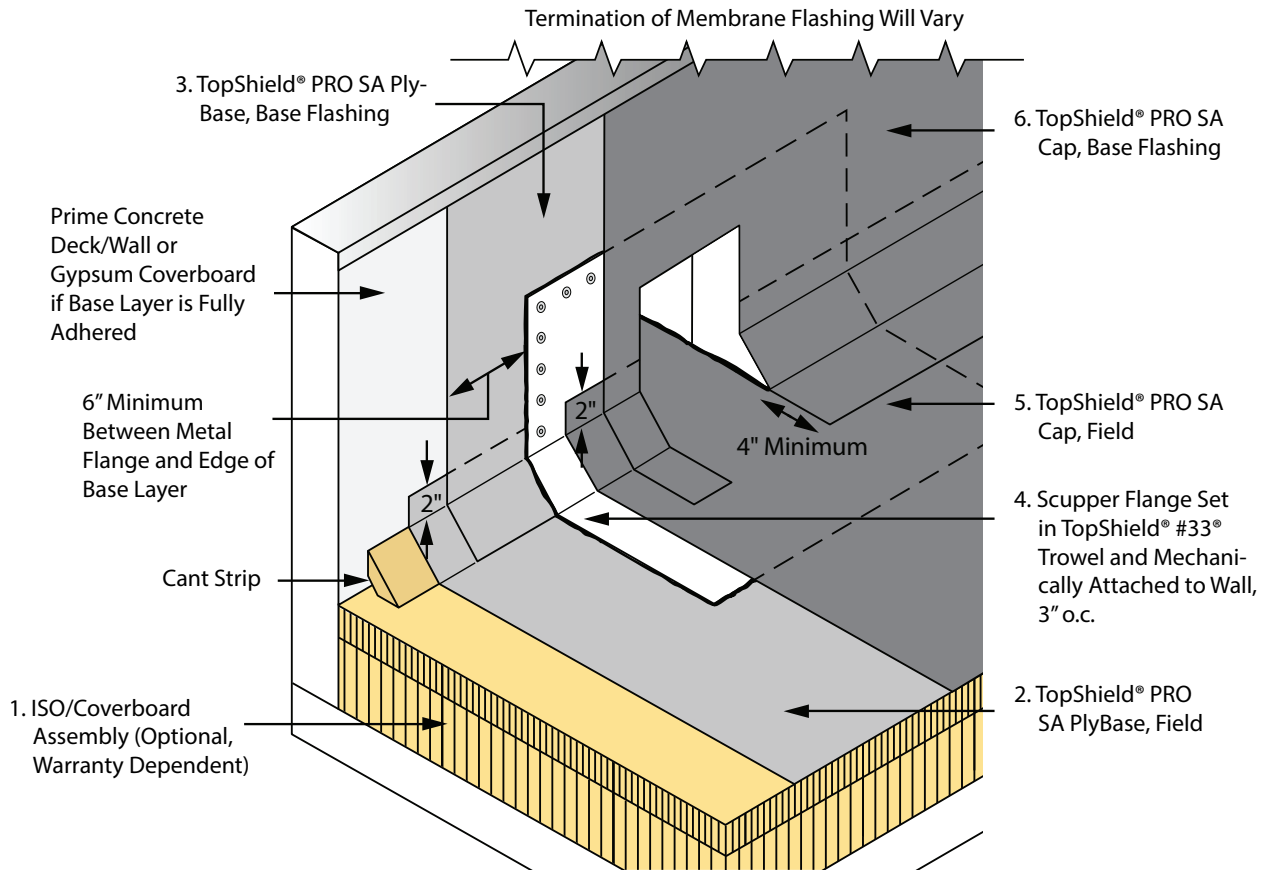

2 PLY SYSTEM SPECIFICATIONS

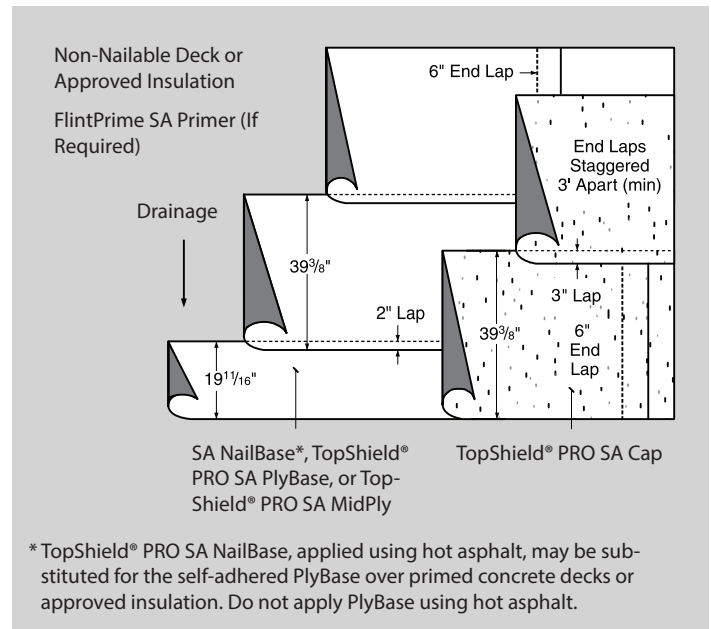
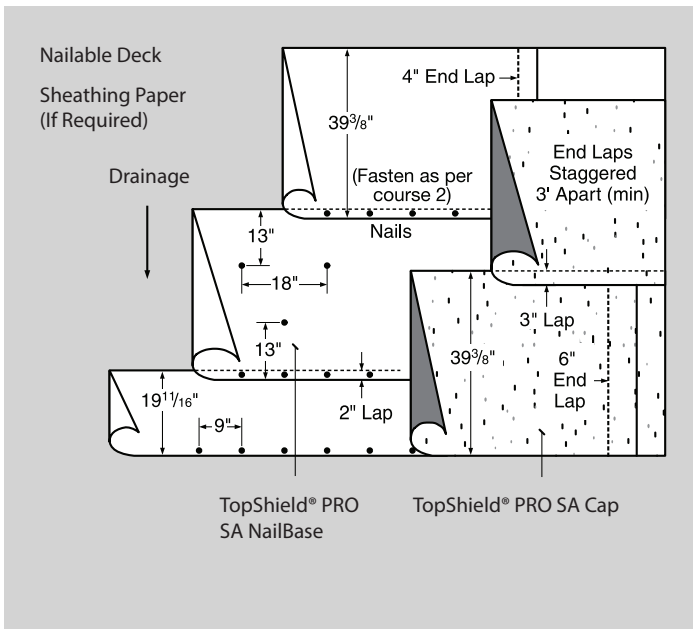

TopShield® PRO SA NailBase, nailed. TopShield® PRO, self-adhered.

For use over nailable decks.

TopShield® PRO SA PlyBase, self-adhered as base ply. TopShield® PRO SA Cap, self-adhered.

For use over non-nailable decks or approved insulation.

	TopShield® PRO SA NailBase	TopShield® PRO SA PlyBase	TopShield® PRO SA Cap
Roll Dimensions	64'6" x 39-3/8"	64'6" x 39-3/8"	32'11" x 39-3/8"
Thickness	1.5 mm	1.5 mm	4.0 mm
Weight	82 lbs	86 lbs	95 lbs
Coverage	2 Squares	2 Squares	1 Square
Top Surface	Permanent Film	Permanent Film	Mineral
Bottom Surface	Sand	Removable Release Film	Removable Release Film
Reinforcement	Fiberglass Mat	Fiberglass Mat	Non-Woven Polyester Mat
Tensile (lb/in)	65/40 (MD/CD)	65/40 (MD/CD)	85/67 (MD/CD)
Elongation (%) (at peak load)	6/5 (MD/CD)	6/5 (MD/CD)	61/66 (MD/CD)
Packaging	Palletized, Bands 20 Rolls Per Pallet	Individual Cartons 20 Rolls Per Pallet	Individual Cartons 20 Rolls Per Pallet



Scan QR code or Visit
TopShieldProducts.com

TOPSHIELD® PRO SA CAP COLORS

TopShield® PRO SA Cap is available in a variety of colors



Gunmetal Gray

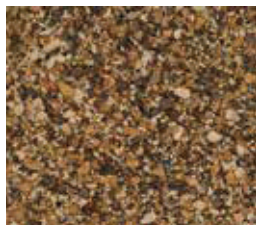

Russet Ridge



Thunder Black

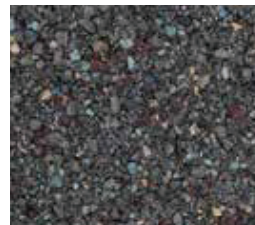

Weathered Wood



White

PRODUCT	WARRANTY PERIOD IN YEARS
TopShield®PRO APP-S	10
TopShield®PRO APP-G	12
TopShield®PRO SA Cap	12

This Limited Warranty applies to product installed in: 2022

UL ER21824-01



FLORIDA BUILDING CODE



Scan QR code or Visit
TopShieldProducts.com



Designed with you in mind

TopShield is an exclusive brand of premium residential roofing products and accessories. Created entirely with the professional contractor's needs in mind, TopShield® Products are always of the highest quality to ensure maximum performance and consistency. We continue to develop TopShield® products with an unwavering focus on increasing our customer's productivity and profitability, while providing the highest level of product performance possible. We understand your needs and we will help you achieve your best! Our customers are always top-of-mind; front-and-center; in everything we do. We are completely committed to your success.

Scan QR code or Visit
[TopShieldProducts.com](https://www.TopShieldProducts.com)

